

**BOTTOM-PLAN VIEW (TOP ONLY)**

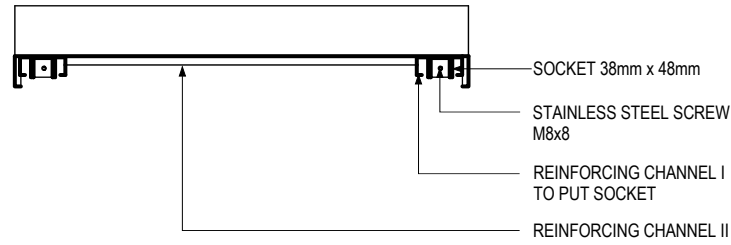

**A-SECTION VIEW  
SCALE 1:15mm**

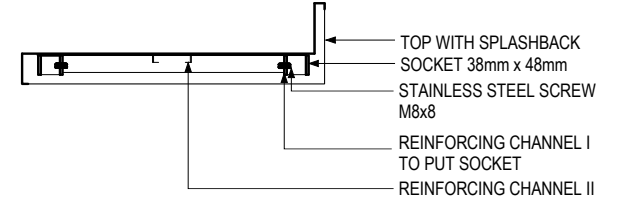

**B-SECTION VIEW  
SCALE 1:15mm**

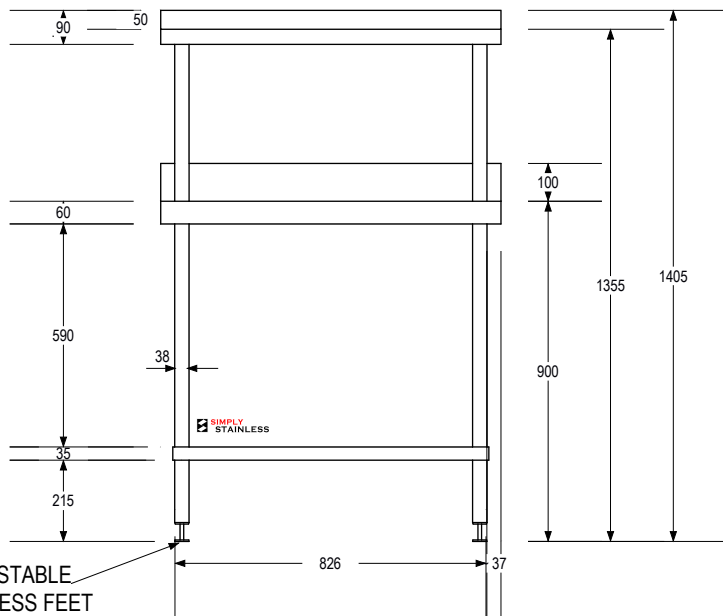

**FRONT VIEW**

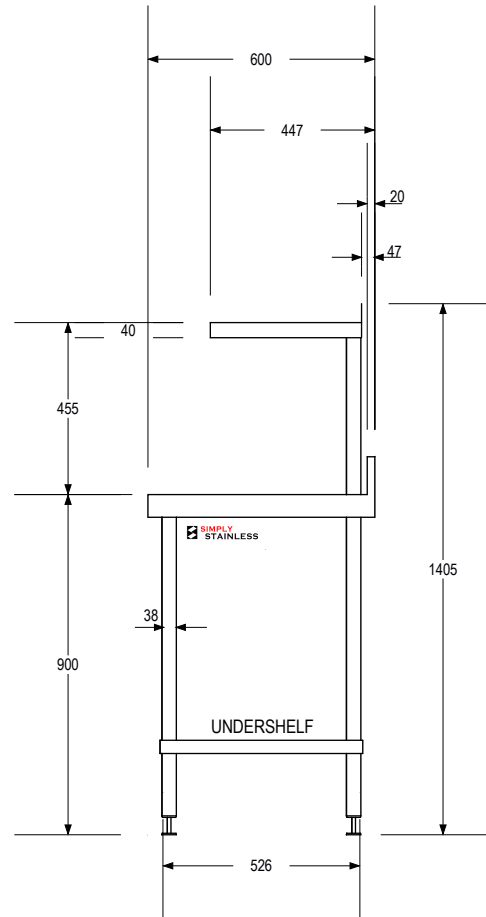

**SIDE VIEW**

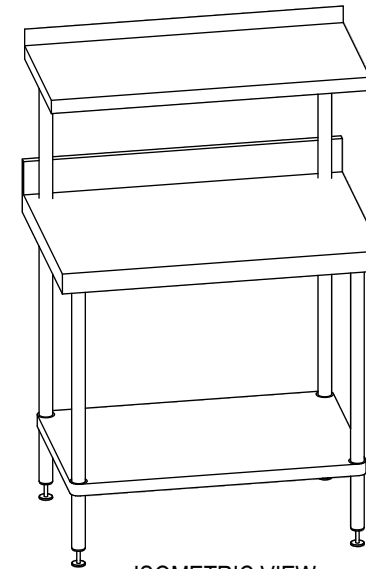

**ISOMETRIC VIEW  
do not scale**

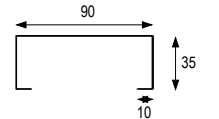

**REINFORCING CHANNEL I  
DETAILS**

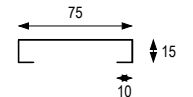

**REINFORCING CHANNEL II  
DETAILS**



www.simplystainless.com  
Modular Sinks Tables and Shelving

COPYRIGHT © 2016

This drawing is the property of CI GROUP PTY LTD. Tradings as SIMPLY STAINLESS and It may not be copied, reproduced or modified in whole or in part without prior written permission of CI GROUP PTY LTD.

**EU 18-6-0900 SALAMANDER BENCH**

scale 1:20

- FULL SS CONSTRUCTION NOTES :**
1. TOP MADE FROM 1.2mm STAINLESS STEEL.
  2. CHANNEL REINFORCING I & II MADE FROM 1.2mm STAINLESS STEEL.
  3. FRAME MADE FROM Ø38mm STAINLESS STEEL TUBE.
  4. UNDERSHELF MADE FROM STAINLESS STEEL.
  5. FEET ARE ADJUSTABLE STAINLESS STEEL DISC SHAPED FEET.